

Spirovent® Drain 14", 16", 18" Air Eliminator and Dirt Separator

Job Name:
Engineer:
Contractor:
Representative:

Tag	Model	Flow	Size	Location

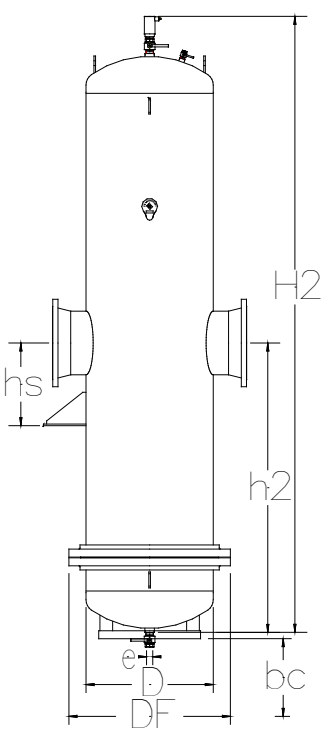

Specifications:

Shell	Steel
Vent Head	Brass
Float	Non-Ferrous
Seal	Viton
O Ring	Viton
Skim Valve	Brass
Coalescing Medium	Copper
Ball Valve	Brass
Max. Working Pressure	150 psig
Max. Operating Temperature	270°F

Notes:
Removable lower head to facilitate cleaning if required.
(bc: Minimum bundle removal clearance)

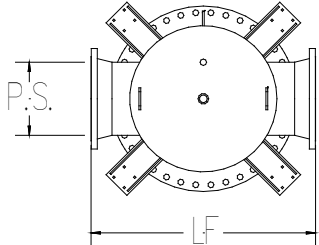

Pipe Size	14"	16"	18"
D (inches)	28	32	36
H2 (inches)	98	110	122
h2 (inches)	43	49	55
LF (inches)	45	50	56
DF (inches)	37	42	46
hs (inches)	20	22	22
e (inches)	2	2	2
bc (inches)	65	69	81
Weight (lbs)	1840	2480	3230
Rec. Flow (gpm)	2530	3300	4180
Model VDN----FA	1400	1600	1800

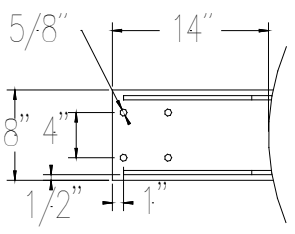

Bracket Detail

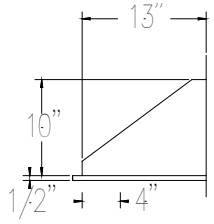

Bracket Detail

(Dimensions for reference only)

Fabricated and stamped in accordance with ASME, Section VIII, Division 1 for unfired pressure vessels.